

**FOTOCELLULE CILINDRICHE M18  
RIFLESSIONE CON CATARIFRANGENTE**

**SERIE OCV81/C *SERIES***

***M18 PHOTOELECTRIC CYLINDRICAL  
SENSORS REFLEX TYPE WITH REAR  
REFLECTOR***

**FOTOCELLULE CILINDRICHE M18 RIFLESSIONE -  
LETTURA A 90° - FREQUENZA DI LAVORO 10kHz  
M18 CYLINDRICAL PHOTOELECTRIC SENSORS - REFLEX TYPE -  
RADIAL CYLINDRICAL HOUSING AND 10 kHz WORKING FREQUENCY**



FOTOCELLULE STANDARD M18 A RIFLESSIONE  
CON CATARIFRANGENTE, CON TESTINA A 90°  
E FREQUENZA DI LAVORO 10 kHz.  
PORTATA 2000 mm O 3000 mm CON  
CATARIFRANGENTE Ø 80 mm.  
USCITA CAVO O CONNETTORE M12.  
CONTENITORE PLASTICO O METALLICO.

*STANDARD M18 PHOTOELECTRIC SENSORS REFLEX  
TYPE, WITH RADIAL CYLINDRICAL HOUSING  
AND 10kHz WORKING FREQUENCY  
SENSING DISTANCE 2000 mm OR 3000 mm WITH  
Ø 80 mm REAR REFLECTOR.  
CABLE OUT OR M12 PLUG-IN CONNECTOR.  
PLASTIC OR METAL BODY.*

**COME ORDINARE**
**HOW TO ORDER**

**OCV81 - / C A P NO R M C5**

**VERSIONE/ VERSION**

- = Versione standard  
Standard version
- K = Versione ad alte  
frequenze 10 kHz  
High frequency  
10 kHz version

**SERIE/ SERIES**

- C = Riflessione con catarifrangente 2000mm,  
(3000mm con catarifrangente Ø 80 mm)  
Reflex with rear reflector 2000mm,  
(3000mm with Ø 80 mm rear reflector)

**TIPO DI OTTICA/ OPTICAL TYPE**

- = Ottica assiale/ Assial optical
- A = Ottica radiale/ Radial optical

**ELETTRONICA/ ELECTRONICS**

- P = PNP (Vcc/Vdc)
- N = NPN (Vcc/Vdc)
- \*C3 = Vca / Vac

\* Non disponibile nelle versioni ad alte frequenze

**CONNESSIONE  
LINK**

- = Cavo (2m)  
Cable (2m)
- Kx = Metraggio cavo a  
richiesta  
Cable lenght upon  
request
- KR = Uscita cavo 90°  
90 degrees angled  
cable output
- C5 = Connettore M12  
M12 Connector

**MATERIALE CORPO  
BODY MATERIAL**

- = Plastico/ Plastic
- M = Metallico/ Metal

**SENSIBILITA'/ SENSITIVITY**

- = Fissa/ Fixed
- R = Regolabile/ Adjustment

**USCITA/ OUTPUT**

- NO = Normalmente aperta (impulso luce)  
Normally open (light on)
- NC = Normalmente chiusa (impulso buio)  
Normally closed (dark-on)
- SC = NO/NC selezionabile (3 Fili)  
NO/NC programmable (3 Wires)
- SC4 = 2 uscite, NO+NC (4 Fili)  
2 outputs, NO +NC (4 Wires)

Le versioni ad alte frequenze sono disponibili solo NO, NC

**CARATTERISTICHE ELETTRICHE**
**GENERALI/ GENERALS**
**ELECTRICAL FEATURES**
**VERSIONE IN C.C.**
**D.C. TYPE**

ALIMENTAZIONE	10 ÷ 30 Vdc	SUPPLY VOLTAGE
ONDULAZIONE RESIDUA	≤ 10%	RIPPLE
ASSORBIMENTO	< 25 mA	POWER CONSUMPTION
CARICO MASSIMO	250 mA	MAXIMUM LOAD
CADUTA DI TENSIONE	< 2V @ 200 mA	VOLTAGE DROP
PROTEZIONE C.C.	SI / YES	SHORT CIRCUIT PROTECTION
PROTEZIONE INVERSIONE DI POLARITA'	SI / YES	POLARITY REVERSAL PROTECTION
COMPATIBILITA' ELETTROMAGNETICA CE	EN 60947-5-2	CE COMPLIANCE

**VERSIONE IN A.C.**
**A.C. TYPE**

ALIMENTAZIONE	20 ÷ 230 Vac	SUPPLY VOLTAGE
ASSORBIMENTO	< 4 mA	POWER CONSUMPTION
CARICO MASSIMO	300 mA	MAXIMUM LOAD
CADUTA DI TENSIONE	< 3 V	VOLTAGE DROP
COMPATIBILITA' ELETTROMAGNETICA CE	EN 60947-5-2	CE COMPLIANCE

**RIFLESSIONE  
CON CATARIFRANGENTE**
**REFLEX  
WITH REAR REFLECTOR**
**CARATTERISTICHE TECNICHE**
**RIFLESSIONE/ REFLEX**
**TECHNICAL FEATURES**

MODELLO	C	CA	*C	*CA	MODEL
	C...R	CA...R	*C...R	*CA...R	
DISTANZA DI RILEVAMENTO (mm)	2000		3000		SENSING DISTANCE (mm)
	2 ÷ 2000		2 ÷ 3000		
EMISSIONE	IR MODULATO 880 nm - PULSED IR 880 nm				EMISSION
FREQUENZA DI COMMUTAZIONE MASSIMA	(C.C.) 150 Hz (D.C.)				MAXIMUM WORKING FREQUENCY
	(C.A.) 25 Hz (A.C.)				
TEMPERATURA DI LAVORO	-10°C ÷ 50°C				WORKING TEMPERATURE
TEMPERATURA DI STOCCAGGIO	-25°C ÷ 70°C				STORAGE TEMPERATURE
MATERIALE CORPO PLASTICO	ABS				PLASTIC BODY MATERIAL
MATERIALE CORPO METALLICO	OTTONE NICHELATO/ NICHEL PLATED BRASS				METAL BODY MATERIAL
MATERIALE LENTI	PMMA				LENSES MATERIAL
GRADO DI PROTEZIONE	IP65				PROTECTION RATING

\* CON CATARIFRANGENTE TIPO SCT4 Ø 80 mm

\* WITH 80 mm Ø REAR REFLECTOR SCT4 TYPE

# RIFLESSIONE AD ALTE FREQUENZE 10 kHz

# 10 kHz WORKING FREQUENCY REFLEX

**CARATTERISTICHE TECNICHE**
**RIFLESSIONE 10 kHz/ 10 kHz REFLEX**
**TECHNICAL FEATURES**

MODELLO	FISSO REG	C C...R	CA CA...R	*C *C...R	*CA *CA...R	FIXED ADJ.	MODEL
DISTANZA DI RILEVAMENTO (mm)	FISSO REG	2000 2 ÷ 2000		3000 2 ÷ 3000		FIXED ADJ.	SENSING DISTANCE (mm)
EMISSIONE	IR MODULATO 880 nm - PULSED IR 880 nm						EMISSION
FREQUENZA DI COMMUTAZIONE MASSIMA	10 kHz						MAXIMUM WORKING FREQUENCY
TEMPERATURA DI LAVORO	-10°C÷50°C						WORKING TEMPERATURE
TEMPERATURA DI STOCCAGGIO	-25°C÷70°C						STORAGE TEMPERATURE
MATERIALE CORPO PLASTICO	ABS						PLASTIC BODY MATERIAL
MATERIALE CORPO METALLICO	OTTONE NICHELATO/ NICHEL PLATED BRASS						METAL BODY MATERIAL
MATERIALE LENTI	PMMA						LENSES MATERIAL
GRADO DI PROTEZIONE	IP66						PROTECTION RATING

\* CON CATARIFRANGENTE TIPO SCT4 Ø 80 mm  
\* WITH 80 mm Ø REAR REFLECTOR SCT4 TYPE

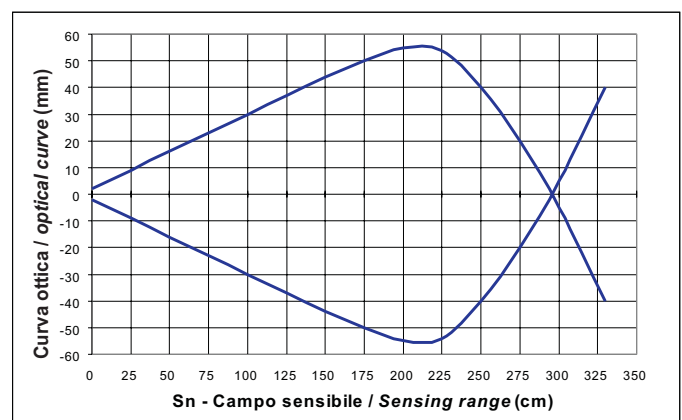
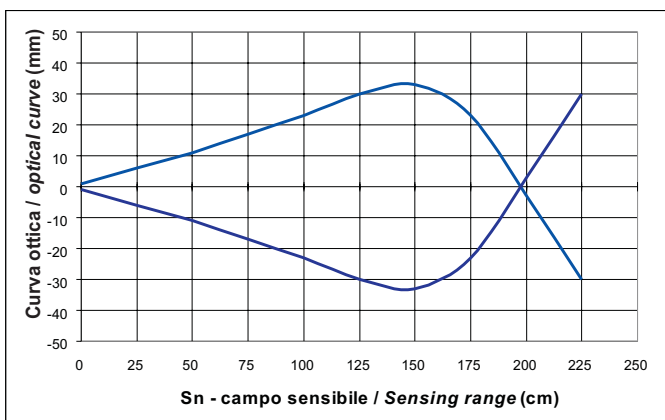
**CURVE OTTICHE**
**OPTIC CURVES**
**MODELLO C, CA TYPE**
**MODELLO C, CA TYPE**
**CATARIFRANGENTE SCT2 REFLECTOR**
**CATARIFRANGENTE SCT4 REFLECTOR**

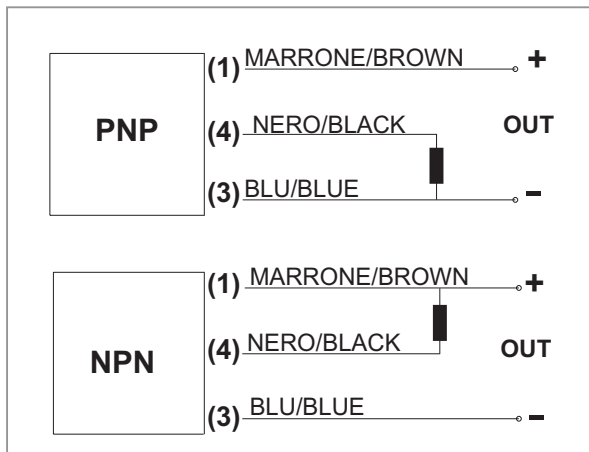
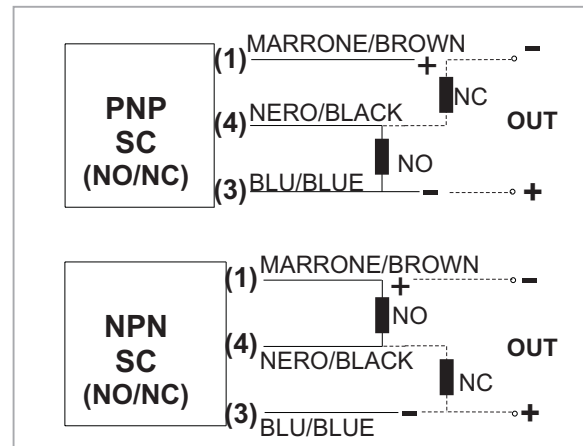
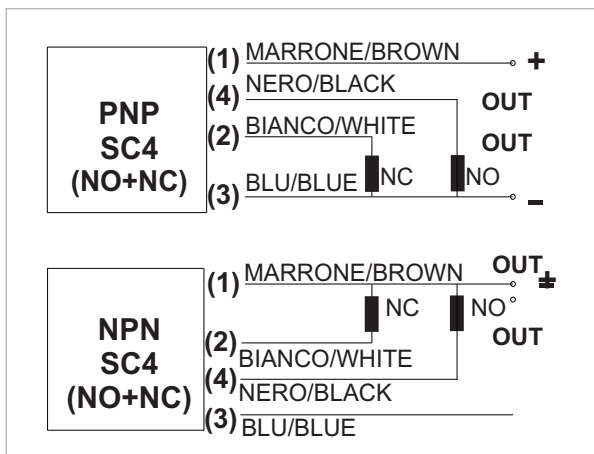
**3 FILI C.C. / 3 WIRES D.C.**

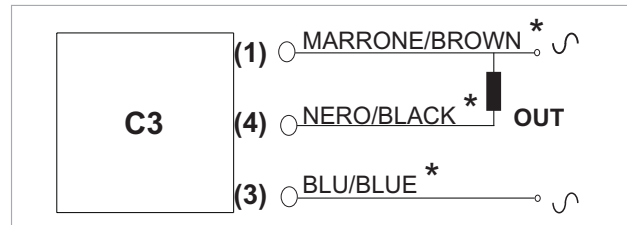
**3 FILI SC (C.C.) / 3 WIRES SC (D.C.)**

**4 FILI SC (C.C.) / 4 WIRES (D.C.)**

**3 FILI C.A. / 3 WIRES (A.C.)  
USCITA CAVO / CABLE OUTPUT**

**3 FILI C.A. / 3 WIRES (A.C.)  
USCITA CONNETTORE / CONNECTOR OUTPUT**

\* COLORE FILI DEL CONNETTORE / CONNECTOR WIRE COLOR

**RIFLESSIONE  
CON CATARIFRANGENTE**
**REFLEX  
WITH REAR REFLECTOR**
**ELENCO PRODOTTI**
**OTTICA ASSIALE / ASSIAL OPTICAL**
**PRODUCTS LIST**
**MODELLO C**
**C TYPE**

USCITA/OUTPUT	PLASTICA / PLASTIC		METALLO / METAL	
	CAVO/CABLE	CONNETTORE/CONNECTOR	CAVO/CABLE	CONNETTORE/CONNECTOR
PNP NO	OCV81/CPNO	OCV81/CPNOC5	OCV81/CPNOM	OCV81/CPNOMC5
PNP NC	OCV81/CPNC	OCV81/CPNCC5	OCV81/CPNCM	OCV81/CPNCMC5
PNP SC	OCV81/CPSC	OCV81/CPSCC5	OCV81/CPSCM	OCV81/CPSCMC5
PNP SC4	OCV81/CPSC4	OCV81/CPSC4C5	OCV81/CPSC4M	OCV81/CPSC4MC5
NPN NO	OCV81/CNNO	OCV81/CNNOC5	OCV81/CNNOM	OCV81/CNNOMC5
NPN NC	OCV81/CNNC	OCV81/CNCC5	OCV81/CNNCM	OCV81/CNNCMC5
NPN SC	OCV81/CNSC	OCV81/CNSCC5	OCV81/CNSCM	OCV81/CNSCMC5
NPN SC4	OCV81/CNSC4	OCV81/CNSC4C5	OCV81/CNSC4M	OCV81/CNSC4MC5
C.A. NO	OCV81/CC3NO	OCV81/CC3NOC5	OCV81/CC3NOM	OCV81/CC3NOMC5
C.A. NC	OCV81/CC3NC	OCV81/CC3NCC5	OCV81/CC3NCM	OCV81/CC3NCMC5

**MODELLO C REGOLABILE**
**C TYPE ADJUSTABLE**

USCITA/OUTPUT	PLASTICA / PLASTIC		METALLO / METAL	
	CAVO/CABLE	CONNETTORE/CONNECTOR	CAVO/CABLE	CONNETTORE/CONNECTOR
PNP NO	OCV81/CPNOR	OCV81/CPNORC5	OCV81/CPNORM	OCV81/CPNORMC5
PNP NC	OCV81/CPNCR	OCV81/CPNCR5	OCV81/CPNCRM	OCV81/CPNCRM5
PNP SC	OCV81/CPSCR	OCV81/CPSCRC5	OCV81/CPSCRM	OCV81/CPSCRM5
PNP SC4	OCV81/CPSC4R	OCV81/CPSC4RC5	OCV81/CPSC4RM	OCV81/CPSC4RM5
NPN NO	OCV81/CNNOR	OCV81/CNNORC5	OCV81/CNNORM	OCV81/CNNORM5
NPN NC	OCV81/CNNCR	OCV81/CNNCR5	OCV81/CNNCRM	OCV81/CNNCRM5
NPN SC	OCV81/CNSCR	OCV81/CNSCRC5	OCV81/CNSCRM	OCV81/CNSCRM5
NPN SC4	OCV81/CNSC4R	OCV81/CNSC4RC5	OCV81/CNSC4RM	OCV81/CNSC4RM5
C.A. NO	OCV81/CC3NOR	OCV81/CC3NORC5	OCV81/CC3NORM	OCV81/CC3NORM5
C.A. NC	OCV81/CC3NCR	OCV81/CC3NCR5	OCV81/CC3NCRM	OCV81/CC3NCRM5

**RIFLESSIONE RADIALE  
CON CATARIFRANGENTE**
**RADIAL REFLEX  
WITH REAR REFLECTOR**
**ELENCO PRODOTTI**
**OTTICA RADIALE/ RADIAL OPTICAL**
**PRODUCTS LIST**
**MODELLO CA**
**AC TYPE**

USCITA/OUTPUT	PLASTICA / PLASTIC		METALLO / METAL	
	CAVO/CABLE	CONNETTORE/CONNECTOR	CAVO/CABLE	CONNETTORE/CONNECTOR
PNP NO	OCV81/CAPNO	OCV81/CAPNOC5	OCV81/CAPNOM	OCV81/CAPNOM5
PNP NC	OCV81/CAPNC	OCV81/CAPNCC5	OCV81/CAPNCM	OCV81/CAPNCM5
PNP SC	OCV81/CAPSC	OCV81/CAPSCC5	OCV81/CAPSCM	OCV81/CAPSCM5
PNP SC4	OCV81/CAPSC4	OCV81/CAPSC4C5	OCV81/CAPSC4M	OCV81/CAPSC4M5
NPN NO	OCV81/CANNO	OCV81/CANNOC5	OCV81/CANNOM	OCV81/CANNOM5
NPN NC	OCV81/CANNC	OCV81/CANNCC5	OCV81/CANNCM	OCV81/CANNCM5
NPN SC	OCV81/CANSC	OCV81/CANSCC5	OCV81/CANSCM	OCV81/CANSCM5
NPN SC4	OCV81/CANSC4	OCV81/CANSC4C5	OCV81/CANSC4M	OCV81/CANSC4M5
C.A. NO	OCV81/CAC3NO	OCV81/CAC3NOC5	OCV81/CAC3NOM	OCV81/CAC3NOM5
C.A. NC	OCV81/CAC3NC	OCV81/CAC3NCC5	OCV81/CAC3NCM	OCV81/CAC3NCM5

**MODELLO CA REGOLABILE**
**CA TYPE ADJUSTABLE**

USCITA/OUTPUT	PLASTICA / PLASTIC		METALLO / METAL	
	CAVO/CABLE	CONNETTORE/CONNECTOR	CAVO/CABLE	CONNETTORE/CONNECTOR
PNP NO	OCV81/CAPNOR	OCV81/CAPNORC5	OCV81/CAPNORM	OCV81/CAPNORM5
PNP NC	OCV81/CAPNCR	OCV81/CAPNCR5	OCV81/CAPNCRM	OCV81/CAPNCRM5
PNP SC	OCV81/CAPSCR	OCV81/CAPSCRC5	OCV81/CAPSCRM	OCV81/CAPSCRM5
PNP SC4	OCV81/CAPSC4R	OCV81/CAPSC4RC5	OCV81/CAPSC4RM	OCV81/CAPSC4RM5
NPN NO	OCV81/CANNOR	OCV81/CANNORC5	OCV81/CANNORM	OCV81/CANNORM5
NPN NC	OCV81/CANNCR	OCV81/CANNCR5	OCV81/CANNCRM	OCV81/CANNCRM5
NPN SC	OCV81/CANSCR	OCV81/CANSCRC5	OCV81/CANSCRM	OCV81/CANSCRM5
NPN SC4	OCV81/CANSC4R	OCV81/CANSC4RC5	OCV81/CANSC4RM	OCV81/CANSC4RM5
C.A. NO	OCV81/CAC3NOR	OCV81/CAC3NORC5	OCV81/CAC3NORM	OCV81/CAC3NORM5
C.A. NC	OCV81/CAC3NCR	OCV81/CAC3NCR5	OCV81/CAC3NCRM	OCV81/CAC3NCRM5

**RIFLESSIONE  
AD ALTE FREQUENZE 10 kHz**
**10 kHz WORKING FREQUENCY  
REFLEX**
**ELENCO PRODOTTI**
**RIFLESSIONE 10 kHz/ 10 kHz REFLEX**
**PRODUCTS LIST**

<b>MODELLO C</b>			<b>C TYPE</b>	
	<b>PLASTICA / PLASTIC</b>		<b>METALLO / METAL</b>	
USCITA/OUTPUT	CAVO/CABLE	CONNETTORE/CONNECTOR	CAVO/CABLE	CONNETTORE/CONNECTOR
<b>PNP NO</b>	OCV81K/CPNO	OCV81K/CPNOC5	OCV81K/CPNOM	OCV81K/CPNOMC5
<b>PNP NC</b>	OCV81K/CPNC	OCV81K/CPNCC5	OCV81K/CPNCM	OCV81K/CPNCMC5
<b>NPN NO</b>	OCV81K/CNNO	OCV81K/CNNOC5	OCV81K/CNNOM	OCV81K/CNNOMC5
<b>NPN NC</b>	OCV81K/CNNC	OCV81K/CNNCC5	OCV81K/CNNCM	OCV81K/CNNCMC5

<b>MODELLO C REGOLABILE</b>			<b>C TYPE ADJUSTABLE</b>	
	<b>PLASTICA / PLASTIC</b>		<b>METALLO / METAL</b>	
USCITA/OUTPUT	CAVO/CABLE	CONNETTORE/CONNECTOR	CAVO/CABLE	CONNETTORE/CONNECTOR
<b>PNP NO</b>	OCV81K/CPNOR	-	OCV81K/CPNORM	OCV81K/CPNORMC5
<b>PNP NC</b>	OCV81K/CPNCR	-	OCV81K/CPNCRM	OCV81K/CPNCRM5
<b>NPN NO</b>	OCV81K/CNNOR	-	OCV81K/CNNORM	OCV81K/CNNORMC5
<b>NPN NC</b>	OCV81K/CNNCR	-	OCV81K/CNNCRM	OCV81K/CNNCRM5

**RIFLESSIONE RADIALE  
AD ALTE FREQUENZE 10 kHz**
**10 kHz WORKING FREQUENCY  
REFLEX RADIAL**
**ELENCO PRODOTTI**
**OTTICA RADIALE 10 kHz/ 10 kHz RADIAL OPTICAL**
**PRODUCTS LIST**

<b>MODELLO C</b>			<b>C TYPE</b>	
	<b>PLASTICA / PLASTIC</b>		<b>METALLO / METAL</b>	
USCITA/OUTPUT	CAVO/CABLE	CONNETTORE/CONNECTOR	CAVO/CABLE	CONNETTORE/CONNECTOR
<b>PNP NO</b>	OCV81K/CAPNO	OCV81K/CAPNOC5	OCV81K/CAPNOM	OCV81K/CAPNOMC5
<b>PNP NC</b>	OCV81K/CAPNC	OCV81K/CAPNCC5	OCV81K/CAPNCM	OCV81K/CAPNCMC5
<b>NPN NO</b>	OCV81K/CANNO	OCV81K/CANNOC5	OCV81K/CANNOM	OCV81K/CANNOMC5
<b>NPN NC</b>	OCV81K/CANNC	OCV81K/CANNCC5	OCV81K/CANNCM	OCV81K/CANNCMC5

<b>MODELLO C REGOLABILE</b>			<b>C TYPE ADJUSTABLE</b>	
	<b>PLASTICA / PLASTIC</b>		<b>METALLO / METAL</b>	
USCITA/OUTPUT	CAVO/CABLE	CONNETTORE/CONNECTOR	CAVO/CABLE	CONNETTORE/CONNECTOR
<b>PNP NO</b>	OCV81K/CPNOR	-	OCV81K/CAPNORM	OCV81K/CAPNORMC5
<b>PNP NC</b>	OCV81K/CAPNCR	-	OCV81K/CAPNCRM	OCV81K/CAPNCRM5
<b>NPN NO</b>	OCV81K/CANNOR	-	OCV81K/CANNORM	OCV81K/CANNORMC5
<b>NPN NC</b>	OCV81K/CANNCR	-	OCV81K/CANNCRM	OCV81K/CANNCRM5

**RIFERIMENTI CONNETTORI PARTE VOLANTE**
**LOOSE PART CONNECTOR CODES**

FEMMINA/FEMALE	DIRITTO / STRAIGHT	90°/90 DEGREES ANGLED CABLE OUTPUT	M12
CAVO / CABLE CEI 20-22 II - L=5m	L70500	C70500	3 POLI / 3 POLES
	L90500	C90500	4 POLI / 4 POLES

**RIFERIMENTI CATARIFRANGENTI**
**REFLECTOR CODES**

Ø 50 mm	Ø 80 mm
SCT2	SCT4

**DIMENSIONI MECCANICHE**

**OTTICA ASSIALE / ASSIAL OPTICAL**

**MECHANICAL SIZE**

**CONTENITORE METALLICO / METAL BODY**

**CONTENITORE PLASTICO / PLASTIC BODY**

**VERSIONE NON REGOLABILE**

**FIXED VERSION**

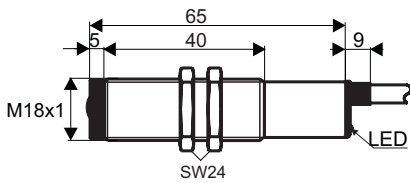

USCITA CAVO 90°  
90 DEGREES ANGLED  
CABLE OUTPUT

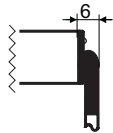

VISTA PARTE SENSIBILE  
SENSITIVE SIDE VIEW

VISTA USCITA CAVO  
CABLE OUTPUT VIEW

VISTA USCITA CAVO 90°  
90 DEGREES ANGLED  
CABLE OUTPUT VIEW



**VERSIONE NON REGOLABILE**

**FIXED VERSION**

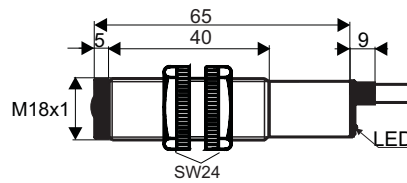

USCITA CAVO 90°  
90 DEGREES ANGLED  
CABLE OUTPUT

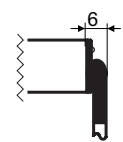

VISTA PARTE SENSIBILE  
SENSITIVE SIDE VIEW

VISTA USCITA CAVO  
CABLE OUTPUT VIEW

VISTA USCITA CAVO 90°  
90 DEGREES ANGLED  
CABLE OUTPUT VIEW



**VERSIONE REGOLABILE**

**ADJUSTABLE VERSION**

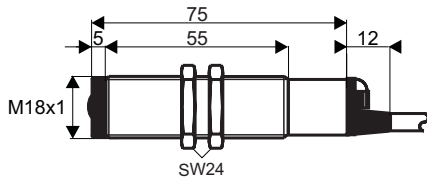

VISTA PARTE SENSIBILE  
SENSITIVE SIDE VIEW

VISTA USCITA CAVO  
CABLE OUTPUT VIEW



**VERSIONE REGOLABILE**

**ADJUSTABLE VERSION**

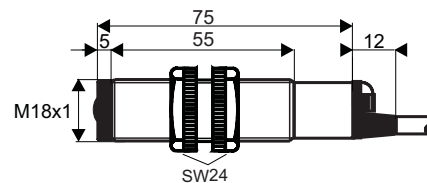

VISTA PARTE SENSIBILE  
SENSITIVE SIDE VIEW

VISTA USCITA CAVO  
CABLE OUTPUT VIEW



**VERSIONE NON REGOLABILE**

**FIXED VERSION**

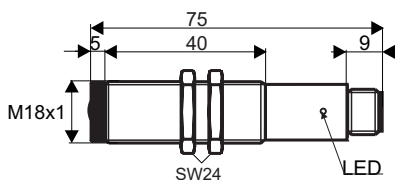

VISTA PARTE SENSIBILE  
SENSITIVE SIDE VIEW

VISTA USCITA CONNETTORE M12  
M12 CONNECTOR OUTPUT VIEW

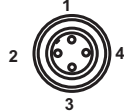

**VERSIONE NON REGOLABILE**

**FIXED VERSION**

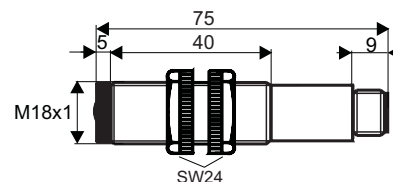

VISTA PARTE SENSIBILE  
SENSITIVE SIDE VIEW

VISTA USCITA CONNETTORE M12  
M12 CONNECTOR OUTPUT VIEW

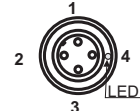



DIMENSIONI MECCANICHE

OTTICA RADIALE / RADIAL OPTICAL

MECHANICAL SIZE

## CONTENITORE METALLICO / METAL BODY

## CONTENITORE PLASTICO / PLASTIC BODY

VERSIONE NON REGOLABILE

FIXED VERSION

VERSIONE NON REGOLABILE

FIXED VERSION

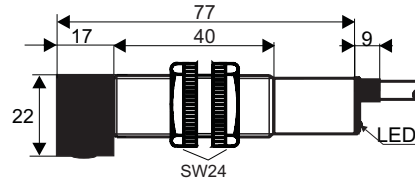
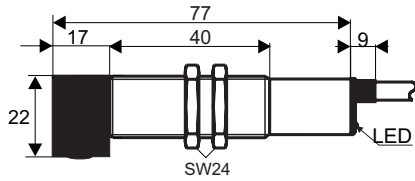

VISTA PARTE SENSIBILE  
SENSITIVE SIDE VIEW

VISTA USCITA CAVO  
CABLE OUTPUT VIEW

VISTA PARTE SENSIBILE  
SENSITIVE SIDE VIEW

VISTA USCITA CAVO  
CABLE OUTPUT VIEW



VERSIONE REGOLABILE

ADJUSTABLE VERSION

VERSIONE REGOLABILE

ADJUSTABLE VERSION

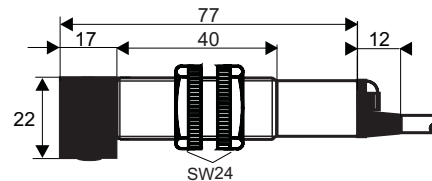
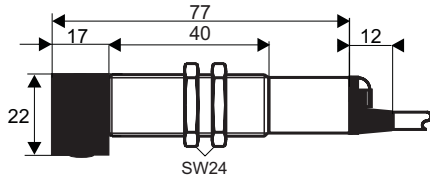

VISTA PARTE SENSIBILE  
SENSITIVE SIDE VIEW

VISTA USCITA CAVO  
CABLE OUTPUT VIEW

VISTA PARTE SENSIBILE  
SENSITIVE SIDE VIEW

VISTA USCITA CAVO  
CABLE OUTPUT VIEW



VERSIONE NON REGOLABILE

FIXED VERSION

VERSIONE NON REGOLABILE

FIXED VERSION

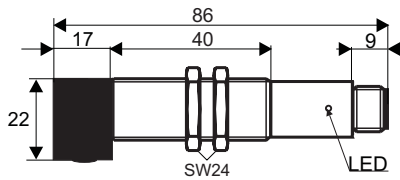

VISTA PARTE SENSIBILE  
SENSITIVE SIDE VIEW

VISTA USCITA CAVO  
CABLE OUTPUT VIEW

VISTA PARTE SENSIBILE  
SENSITIVE SIDE VIEW

VISTA USCITA CONNETTORE M12  
M12 CONNECTOR OUTPUT VIEW

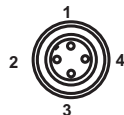

VERSIONE REGOLABILE

ADJUSTABLE VERSION

VISTA PARTE SENSIBILE  
SENSITIVE SIDE VIEW

VISTA USCITA CONNETTORE M12  
M12 CONNECTOR OUTPUT VIEW

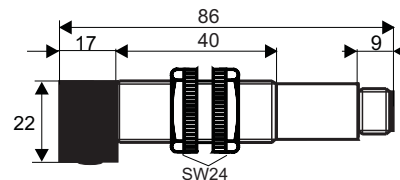
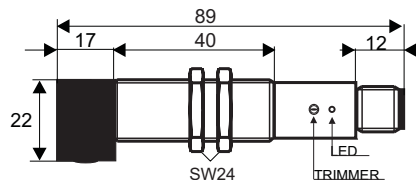

VISTA PARTE SENSIBILE  
SENSITIVE SIDE VIEW

VISTA USCITA CONNETTORE M12  
M12 CONNECTOR OUTPUT VIEW

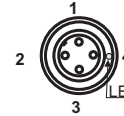
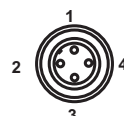

**Altri prodotti**

- interruttori di prossimità induttivi;
- interruttori di prossimità capacitivi;
- interruttori di prossimità magnetici;
- interruttori di prossimità fotoelettrici;
  
- connettori e cassette di connessione per sensori;
  
- encoder incrementali ed assoluti;
  
- alimentatori / interfacce per sensori;
- alimentatori da rete e da secondario per uso generico;
  
- voltmetri, amperometri, contagiri, visualizzatori a pannello;
- contaimpulsi mono e bidirezionali, contaproduzione, contagiri;
- termometri e termoregolatori
  
- schede logiche programmabili per uso OEM;
  
- pulsanteria e finecorsa meccanici;

***Other products:***

- *inductive proximity switches;*
- *capacitive proximity switches;*
- *magnetic proximity switches;*
- *photo-electric sensors & proximity switches;*
  
- *connectors & connection boxes for sensor;*
  
- *incremental & absolute encoders;*
  
- *supply units / interfaces for sensors;*
- *power supply units for general purpose;*
  
- *voltmeters, ammeters, revolution counters, panel displays;*
- *counters mono & bi-directional, timers, revolution counters;*
- *thermometers & temperature controllers;*
  
- *OEM programmable logic cards;*
  
- *push-button & mechanical limit switches;*