

ABSOLUTE ENCODERS

AMT58

SSI® Multi-turn Line

- Standard dimension Ø58mm
- Hollow or solid shaft
- Very high resolution
- Very high accuracy



APPLICATIONS

- Motion control
- Automated machinery
- Length measurement and positioning



MECHANICAL AND ENVIRONMENTAL SPECIFICATIONS

Case dimension	Ø 58 mm, depth 48 mm
Shaft dimension	Hollow Ø 15 mm, solid Ø 6 or 10 mm
Shaft loading (axial and radial)	100 N max.
Shaft rotational speed	9000 rpm continuous, 12000 rpm temporary
Bearings life	400x10 ⁶ rev. min. (10 ⁹ rev. min. with shaft loading of 20 N max.)
Weight	0.3 kg (10 oz) ca.
Case material	Aluminium anticorodal UNI EN AW-6082
Flange material	Aluminium anticorodal UNI EN AW-6082
Shaft material	Stainless steel non-magnetic UNI EN 4305
Bearings material	ABEC 5
Mechanical protection	IP65
Shock resistance	100g, 6 ms (MIL STD 202F)
Vibration resistance	10 g, 5-2000 Hz (MIL STD 202F)
Operating temperature	-25 to +85°C (-13 to 185°F)
Storage temperature	-40 to +100°C (-40 to 212°F), 98% R.H. non condensing

Note: specifications subject to changes without prior notice, please refer to the user manual received with the product for mounting, wiring and operation.

ELECTRICAL SPECIFICATIONS

Resolution	13 x 12 bit = up to 8192 CPR x 4096 turns
Counting frequency	220 kHz max.
Accuracy	±0.007°
Output code	GRAY
Output circuit	SSI® (RS422) tree format
Power supply	7.5 – 34 Vdc
Consumption	1 W
Input functions	Counting direction and Zero setting/Preset
Connection	8-poles shielded cable 1.5m or connector M12 or M23
Protection	Polarity inversion and short circuit
EMC	According to EN61000-4-2/A1 and EN61000-4-4
Light source	Ga-Al diodes
Optoelectronic life	> 100.000 hrs

ELECTRICAL CONNECTIONS

SSI®	0 Vdc	+Vdc	Clock in+	Clock in-	Data out+	Data out-	Preset	Direction	Ground
Wire	White	Brown	Green	Yellow	Gray	Pink	Blue	Red	Shield
M12 pin	1	2	3	4	5	6	7	8	Case
M23 pin	1	2	3	4	5	6	7	8	Case

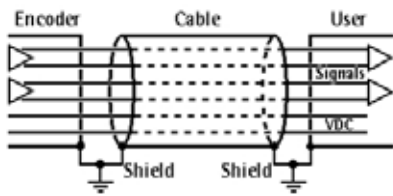

8-poles cable

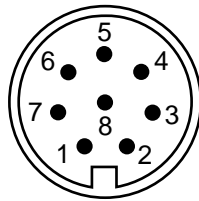

M12 8-pin connector

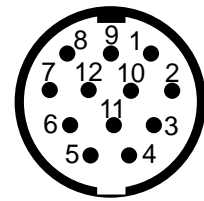

M23 12-pin connector ccw
(only 8 pins are used)

NOTE: view and pin-out of the connectors on the encoder side

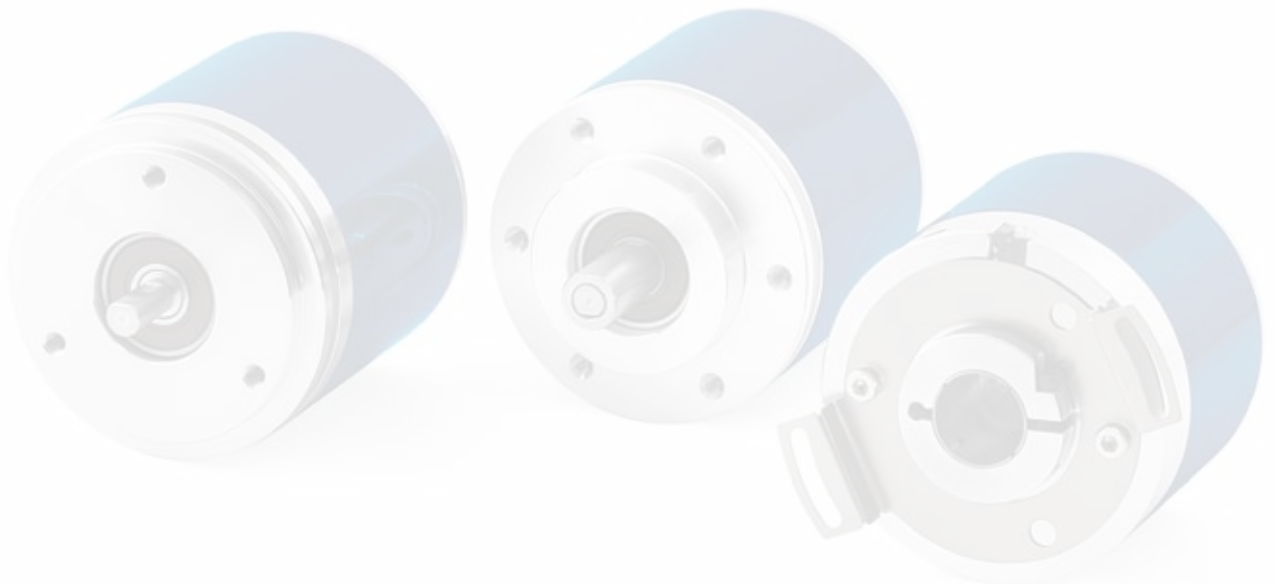

ABSOLUTE ENCODERS

DIMENSIONS

HOLLOW SHAFT VERSION

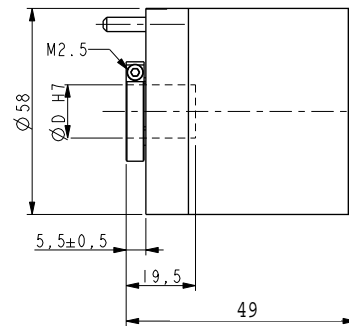
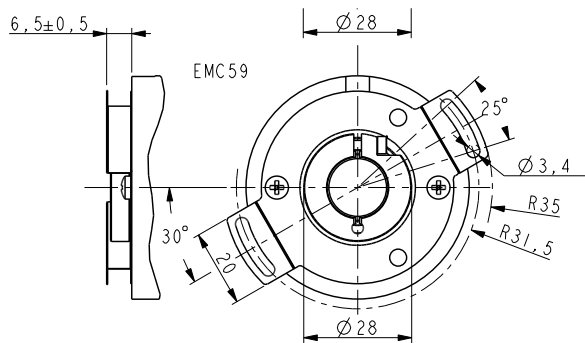

SOLID SHAFT VERSION

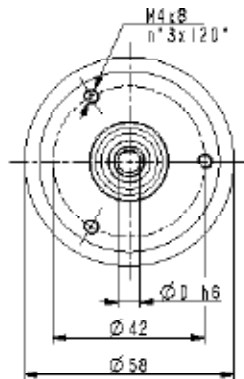

AMT58-S06

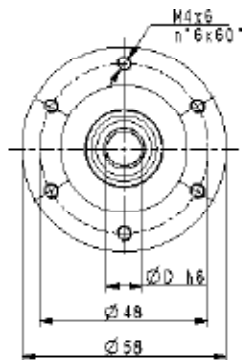
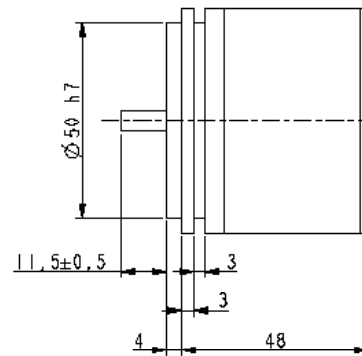

AMT58-S10

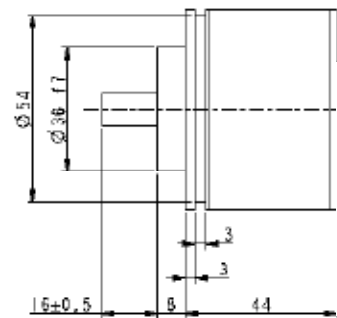

Model selection

SSI® MULTI-TURN MODELS

SHAFT	CONNECTION	MODEL	ORDER NO.
Hollow shaft Ø15 mm	Cable 1.5m	AMT58-H15-13x12-C15	95B081140
	M12 conn.	AMT58-H15-13x12-M12	95B081120
	M23 conn.	AMT58-H15-13x12-M23	95B081130
Solid shaft • Ø6 mm	Cable 1.5m	AMT58-S06-13x12-C15	95B081080
	M12 conn.	AMT58-S06-13x12-M12	95B081060
	M23 conn.	AMT58-S06-13x12-M23	95B081070
Solid shaft • Ø10 mm	Cable 1.5m	AMT58-S10-13x12-C15	95B081110
	M12 conn.	AMT58-S10-13x12-M12	95B081090
	M23 conn.	AMT58-S10-13x12-M23	95B081100

ACCESSORIES

DESCRIPTION	MODEL	ORDER NO.
Flexible Aluminium coupling Ø6 mm	FAC06-06	95B081300
Flexible Aluminium coupling Ø10 mm	FAC10-10	95B081310
Flexible standard plastic coupling Ø6 mm	FBC06-06	95B081320
Flexible standard plastic coupling Ø10 mm	FBC10-10	95B081330
Encoder reducing sleeve Ø15 - 6 mm	RS15-06	95B081340
Encoder reducing sleeve Ø15 - 8 mm	RS15-08	95B081350
Encoder reducing sleeve Ø15 - 10 mm	RS15-10	95B081360
Encoder reducing sleeve Ø15 - 11 mm	RS15-11	95B081370
Encoder reducing sleeve Ø15 - 12 mm	RS15-12	95B081380
Encoder reducing sleeve Ø15 - 9.52 mm (3/8")	RS15-3/8	95B081390
Ø58 Encoder fixing clamps (3 kits)	ST-58-KIT	95B081400
Ø58 Encoder mounting bell	ST-58-BELL	95B081410
Ø58 Encoder mounting L-bracket	ST-58-BRKT	95B081420
Ø58 Encoder mounting square flange	ST-58-FLNG	95B081430
Absolute encoder conn. ccw M23 12-poles with 5m cable	CN-M23A-12P-05	95B081290
Absolute encoder conn. ccw M23 12-poles with 10m cable	CN-M23A-12P-10	95B081450
Absolute encoder conn. ccw M23 12-poles without cable	CN-M23A-12P-00	95B081470
Metal M12 8-poles female conn. with 5m cable	CN-M12-08P-05	95B081230
Metal M12 8-poles female conn. with 10m cable	CN-M12-08P-10	95B081240
Metal M12 8-poles female connector without cable	CN-M12-08P-00	95B081250
UL Plastic M12 8-poles female conn. with 3m cable	CS-A1-06-U-03	95ASE1170
UL Plastic M12 8-poles female conn. with 5m cable	CS-A1-06-U-05	95ASE1180
UL Plastic M12 8-poles female conn. with 10m cable	CS-A1-06-U-10	95ASE1190
UL Plastic M12 8-poles female conn. with 15m cable	CS-A1-06-U-15	95ASE1200
UL Plastic M12 8-poles female conn. with 25m cable	CS-A1-06-U-25	95ASE1210
UL Plastic M12 8-poles female conn. with 50m cable	CS-A1-06-U-50	95A252700
UL Plastic M12 8-poles female connector without cable	CS-A1-06-B-NC	95ACC2550

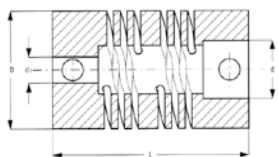

FAC06-06 (L22/D19/d6 mm)
FAC10-10 (L24/D25/d10 mm)

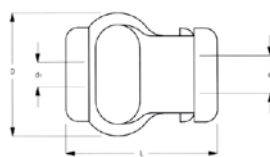

FBC06-06 (L29/D22/d6 mm)
FBC10-10 (L29/D22/d10 mm)

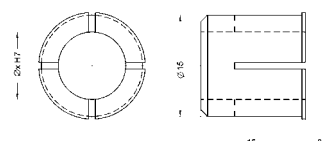

RS15-xx (int. Ø as specified in description)

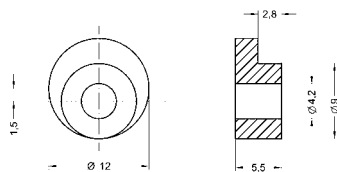

ST58-KIT

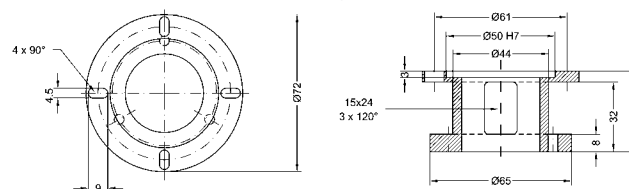

ST-58-BELL

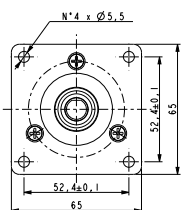

ST-58-FLNG

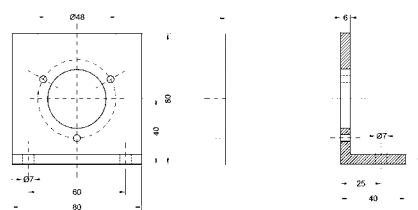

ST-58-BRKT

ABSOLUTE ENCODERS

AMT58-Modular Fieldbus

Multi-turn with Modular Fieldbus interface

- Standard dimension $\varnothing 58\text{mm}$
- Hollow or solid shaft
- Extremely high accuracy
- Modular Fieldbus interface



APPLICATIONS

- Motion control
- Automated machinery
- Length measurement and positioning



MECHANICAL AND ENVIRONMENTAL SPECIFICATIONS

Case dimension	$\varnothing 58\text{ mm}$, depth 71 mm (encoder + interface module)
Shaft dimension	Hollow $\varnothing 15\text{ mm}$, solid $\varnothing 6$ or 10 mm
Shaft loading (axial and radial)	100 N max.
Shaft rotational speed	9000 rpm continuous, 12000 rpm temporary
Bearings life	400x10 ⁶ rev. min. (10 ⁶ rev. min. with shaft loading of 20 N max.)
Weight	0.3 kg (10 oz) ca.
Case material	Aluminium anticorodal UNI EN AW-6082
Flange material	Aluminium anticorodal UNI EN AW-6082
Shaft material	Stainless steel non-magnetic UNI EN 4305
Bearings material	ABEC 5
Mechanical protection	IP65
Shock resistance	100g, 6 ms (MIL STD 202F)
Vibration resistance	10 g, 5-2000 Hz (MIL STD 202F)
Operating temperature	-25 to +85°C (-13 to 185°F)
Storage temperature	-40 to +100°C (-40 to 212°F), 98% R.H. non condensing

Note: specifications subject to changes without prior notice, please refer to the user manual received with the product for mounting, wiring and operation.

ELECTRICAL SPECIFICATIONS

Resolution	16 x 14 bit = up to 65536 CPR x 16384 turns
Counting frequency	220 kHz max.
Accuracy	±0.007°
Output interface	CANopen®DS310, DS406, DeviceNet, Profibus DP V1
Power supply	7.5 – 34 Vdc
Consumption	2.2 W
Input functions	Counting direction and Zero setting/Preset
Connection	connector M12
Protection	Polarity inversion and short circuit
EMC	EN50081-2, EN50082-2
Light source	Ga-Al diodes
Optoelectronic life	> 100.000 hrs

ELECTRICAL CONNECTIONS

CANopen or Devicenet

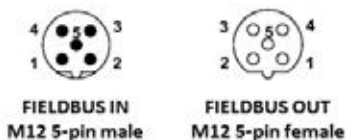

M12 5-pin I/O		
CAN Shield	Case	1
+10...30Vdc	+	2
0Vdc	-	3
CAN High	H	4
CAN Low	L	5

Profibus-DP



M12 3-pin	
+10...30Vdc	1
0Vdc	3
Shield	4

M12 5-pin I/O		
n.c.		1
Profibus A	Green	2
n.c.		3
Profibus B	Red	4
n.c.		5

NOTE: view and pin-out of the connectors on the encoder side

ABSOLUTE ENCODERS

DIMENSIONS

HOLLOW SHAFT VERSION

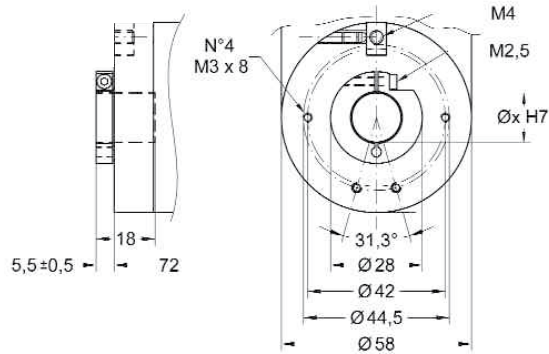

SOLID SHAFT VERSION

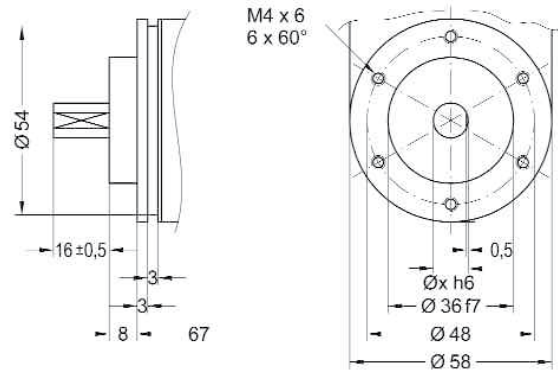

ENCODER WITH FIELDBUS INTERFACE MODULE

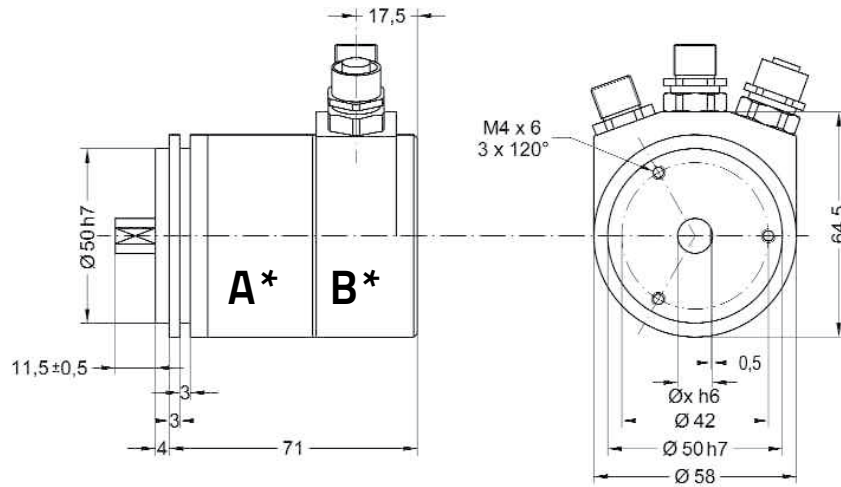

*The encoder base unit "A" must be connected to the required Fieldbus interface module "B".

MULTI-TURN BASE MODELS FOR FIELDBUS MODULES

SHAFT	MODEL	ORDER NO.
Encoder base unit with hollow shaft \varnothing 15 mm	AMT58-H15-16x14-FBUS	95B081170
Encoder base unit with solid shaft \bullet \varnothing 6 mm	AMT58-S06-16x14-FBUS	95B081150
Encoder base unit with solid shaft \bullet \varnothing 10 mm	AMT58-S10-16x14-FBUS	95B081160

FIELDBUS INTERFACE MODULES

FIELDBUS MODULE	MODEL	ORDER NO.
CANopen® interface module*	AMT58-FBUS-CB	95B081190
Devicenet interface module*	AMT58-FBUS-DN	95B081200
Profibus DP interface module*	AMT58-FBUS-PB	95B081180

* The encoder base unit must be ordered with the Fieldbus interface module

ACCESSORIES

DESCRIPTION	MODEL	ORDER NO.
Flexible Aluminium coupling Ø6 mm	FAC06-06	95B081300
Flexible Aluminium coupling Ø10 mm	FAC10-10	95B081310
Flexible standard plastic coupling Ø6 mm	FBC06-06	95B081320
Flexible standard plastic coupling Ø10 mm	FBC10-10	95B081330
Encoder reducing sleeve Ø15 - 6 mm	RS15-06	95B081340
Encoder reducing sleeve Ø15 - 8 mm	RS15-08	95B081350
Encoder reducing sleeve Ø15 - 10 mm	RS15-10	95B081360
Encoder reducing sleeve Ø15 - 11 mm	RS15-11	95B081370
Encoder reducing sleeve Ø15 - 12 mm	RS15-12	95B081380
Encoder reducing sleeve Ø15 - 9.52 mm (3/8")	RS15-3/8	95B081390
Ø58 Encoder fixing clamps (3 kits)	ST-58-KIT	95B081400
Ø58 Encoder mounting bell	ST-58-BELL	95B081410
Ø58 Encoder mounting L-bracket	ST-58-BRKT	95B081420
Ø58 Encoder mounting square flange	ST-58-FLNG	95B081430
Canopen/Devicenet 2 connectors kit	CN-M12-CB/DN-KIT	95B081690
Canopen/Devicenet output cable	CN-M12-5P-5M-CB/DN-O	95B081700
Canopen/Devicenet input cable	CN-M12-5P-5M-CB/DN-I	95B081710
Profibus 3 connectors kit	CN-M12-PBUS-KIT	95B081720
Profibus power supply cable	CN-M12-4P-5M-BUS-PS	95B081730
Profibus input cable	CN-M12-5P-5M-PBUS-I	95B081740
Profibus output cable	CN-M12-5P-5M-PBUS-O	95B081750

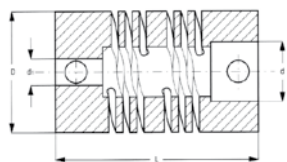

FAC06-06 (L22/D19/d6 mm)
FAC10-10 (L24/D25/d10 mm)

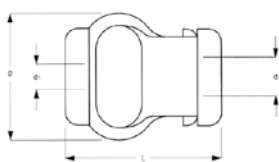

FBC06-06 (L29/D22/d6 mm)
FBC10-10 (L29/D22/d10 mm)

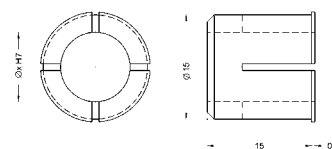

RS15-xx (int. Ø as specified in description)

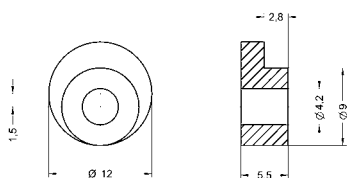

ST58-KIT

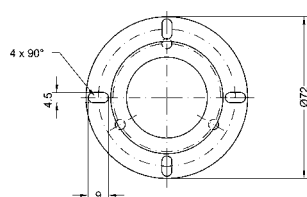

ST-58-BELL

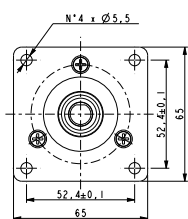
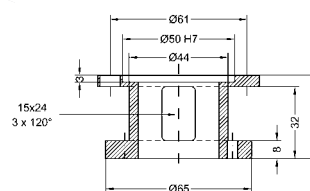

ST-58-FLNG

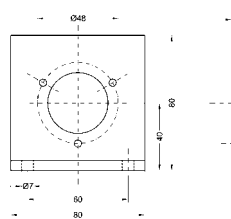

ST-58-BRKT

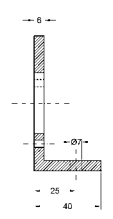

ABSOLUTE ENCODERS

AMT58-Integrated Fieldbus

Multi-turn with Integrated Fieldbus interface

- Standard dimension Ø58mm
- Very high resolution
- Extremely high accuracy
- Integrated Fieldbus interface



APPLICATIONS

- Motion control
- Automated machinery
- Length measurement and positioning

CANopen

DeviceNet



EtherCAT

PROFI
BUS

PROFI
NET

CE C RA US

MECHANICAL AND ENVIRONMENTAL SPECIFICATIONS

Case dimension	Ø 58 mm, depth 71 mm (encoder + interface module)
Shaft dimension	Solid Ø 10 mm
Shaft loading (axial and radial)	100 N max.
Shaft rotational speed	9000 rpm continuous, 12000 rpm temporary
Bearings life	400x10 ⁶ rev. min. (10 ⁹ rev. min. with shaft loading of 20 N max.)
Weight	0.3 kg (10 oz) ca.
Case material	Aluminium anticorodal UNI EN AW-6082
Flange material	Aluminium anticorodal UNI EN AW-6082
Shaft material	Stainless steel non-magnetic UNI EN 4305
Bearings material	ABEC 5
Mechanical protection	IP65
Shock resistance	100g, 6 ms (MIL STD 202F)
Vibration resistance	10 g, 5-2000 Hz (MIL STD 202F)
Operating temperature	-25 to +85°C (-13 to 185°F)
Storage temperature	-40 to +100°C (-40 to 212°F), 98% R.H. non condensing

Note: specifications subject to changes without prior notice, please refer to the user manual received with the product for mounting, wiring and operation.

ELECTRICAL SPECIFICATIONS

Resolution	13 x 12 bit = 8192 CPR x 4096 turns / 13 x 14 bit = 8192 CPR x 16384 turns
Counting frequency	220 kHz max.
Accuracy	±0.007°
Output interface	Canopen, Devicenet, Ethercat, Profibus, Profinet
Power supply	7.5 – 34 Vdc
Consumption	2.2 W
Input functions	Counting direction and Zero setting/Preset
Connection	connector M12
Protection	Polarity inversion and short circuit
EMC	EN50081-2, EN50082-2
Light source	Ga-Al diodes
Optoelectronic life	> 100.000 hrs

ELECTRICAL CONNECTIONS

CANopen or Devicenet

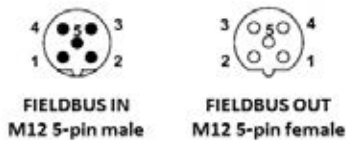

M12 5-pin I/O		
CAN Shield	Case	1
+10...30Vdc	+	2
0Vdc	-	3
CAN High	H	4
CAN Low	L	5

Profibus-DP



M12 3-pin	
+10...30Vdc	1
0Vdc	3
Shield	4

M12 5-pin I/O		
n.c.		1
Profibus A	Green	2
n.c.		3
Profibus B	Red	4
n.c.		5

EtherCAT

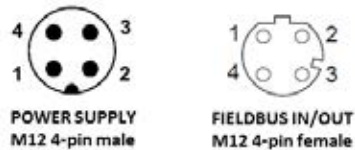

M12 4-pin PS	
+10...30Vdc	1
n.c.	2
0Vdc	3
n.c.	4

M12 4-pin I/O	
TX Data +	1
RX Data +	2
TX Data -	3
RX Data -	4

Profinet



M12 4-pin P1	
TX Data +	1
RX Data +	2
TX Data -	3
RX Data -	4

M12 4-pin PS	
+10...30Vdc	1
n.c.	2
0Vdc	3
n.c.	4

M12 4-pin P2	
TX Data +	1
RX Data +	2
TX Data -	3
RX Data -	4

NOTE: view and pin-out of the connectors on the encoder side

ABSOLUTE ENCODERS

DIMENSIONS

ENCODER WITH INTEGRATED FIELDBUS INTERFACE

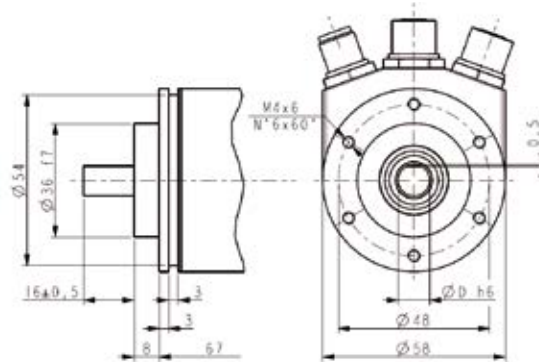

Model selection

INTEGRATED FIELDBUS MODELS					
SHAFT	CONNECTION	INTERFACE	RESOLUTION	MODEL	ORDER NO.
Solid shaft Ø10 mm	M12	Canopen	13x12 bit	AMT58-S10-13x12-CB	95B081630
Hollow shaft Ø15 mm	M12	Canopen	13x12 bit	AMT58-H15-13x12-CB	95B081640
Solid shaft Ø10 mm	M12	Devicenet	13x12 bit	AMT58-S10-13x12-DN	95B081650
Hollow shaft Ø15 mm	M12	Devicenet	13x12 bit	AMT58-H15-13x12-DN	95B081660
Solid shaft Ø10 mm	M12	Ethercat	13x14 bit	AMT58-S10-13x14-EC	95B081220
Hollow shaft Ø15 mm	M12	Ethercat	13x14 bit	AMT58-H15-13x14-EC	95B081680
Solid shaft Ø10 mm	M12	Profibus	13x12 bit	AMT58-S10-13x12-PB	95B081610
Hollow shaft Ø15 mm	M12	Profibus	13x12 bit	AMT58-H15-13x12-PB	95B081620
Solid shaft Ø10 mm	M12	Profinet	13x14 bit	AMT58-S10-13x14-PN	95B081210
Hollow shaft Ø15 mm	M12	Profinet	13x14 bit	AMT58-H15-13x14-PN	95B081670

ACCESSORIES		
DESCRIPTION	MODEL	ORDER NO.
Flexible Aluminium coupling Ø6 mm	FAC06-06	95B081300
Flexible Aluminium coupling Ø10 mm	FAC10-10	95B081310
Flexible standard plastic coupling Ø6 mm	FBC06-06	95B081320
Flexible standard plastic coupling Ø10 mm	FBC10-10	95B081330
Encoder reducing sleeve Ø15 - 6 mm	RS15-06	95B081340
Encoder reducing sleeve Ø15 - 8 mm	RS15-08	95B081350
Encoder reducing sleeve Ø15 - 10 mm	RS15-10	95B081360
Encoder reducing sleeve Ø15 - 11 mm	RS15-11	95B081370
Encoder reducing sleeve Ø15 - 12 mm	RS15-12	95B081380
Encoder reducing sleeve Ø15 - 9.52 mm (3/8")	RS15-3/8	95B081390
Ø58 Encoder fixing clamps (3 kits)	ST-58-KIT	95B081400
Ø58 Encoder mounting bell	ST-58-BELL	95B081410
Ø58 Encoder mounting L-bracket	ST-58-BRKT	95B081420
Ø58 Encoder mounting square flange	ST-58-FLNG	95B081430
Canopen/Devicenet 2 connectors kit	CN-M12-CB/DN-KIT	95B081690
Canopen/Devicenet output cable	CN-M12-5P-5M-CB/DN-O	95B081700
Canopen/Devicenet input cable	CN-M12-5P-5M-CB/DN-I	95B081710
Profibus 3 connectors kit	CN-M12-PBUS-KIT	95B081720
Ecat/Pbus/Pnet power supply cable	CN-M12-4P-5M-BUS-PS	95B081730
Profibus input cable	CN-M12-5P-5M-PBUS-I	95B081740
Profibus output cable	CN-M12-5P-5M-PBUS-O	95B081750
Ethercat/Profinet programming cable	CN-M12-4P-5M-EC/PN-RJ	95B081770
Ethercat/Profinet input-output cable	CN-M12-4P-5M-EC/PN-IO	95B081780
Ethercat/Profinet input-output plug	CN-M12-4P-00-EC/PN-IO	95B081790

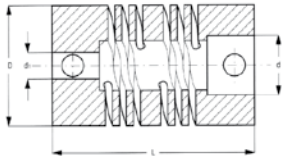

FAC06-06 (L22/D19/d6 mm)
FAC10-10 (L24/D25/d10 mm)

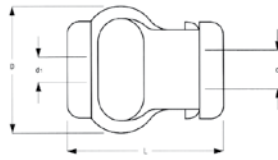

FBC06-06 (L29/D22/d6 mm)
FBC10-10 (L29/D22/d10 mm)

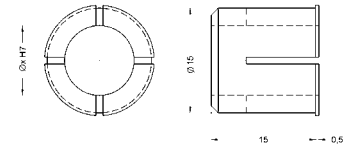

RS15-xx (int. Ø as specified in description)

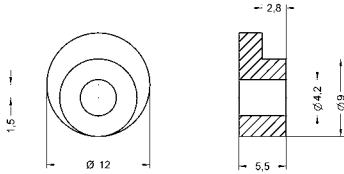

ST58-KIT

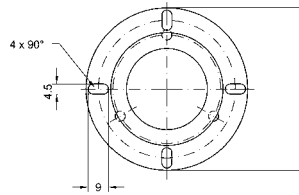

ST58-BELL

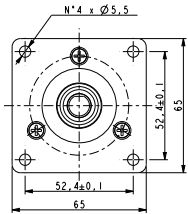
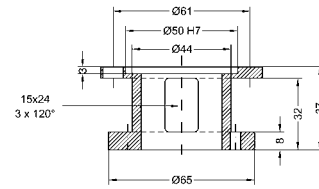

ST58-FLNG

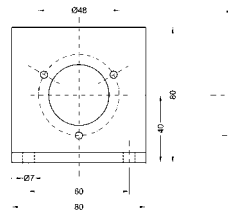

ST58-BRKT

